



Operation Options:

- Chain hoist operation
- Motor operation

Safety Options:

- Cable broken devices
- Safety edges
- Safety photo eyes

Perfect applications where thermal performance and rugged durability are key

Ryterna Distributor:

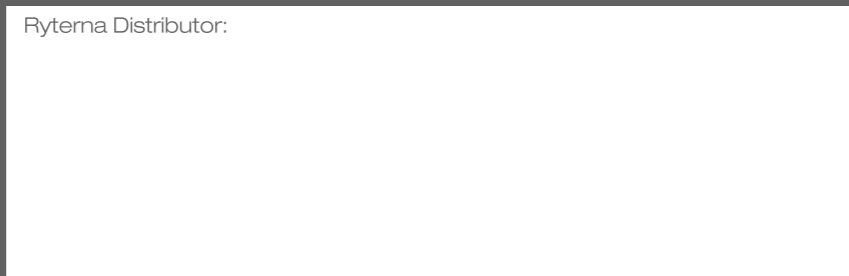

Thermo Solution
by RYTERNA

www.ryterna.eu

80mm
PU insulated
Panels

TLP - ULTRA THERMO DOORS

For Maximal Energy Efficiency



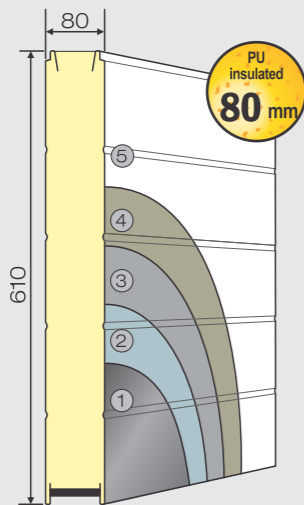
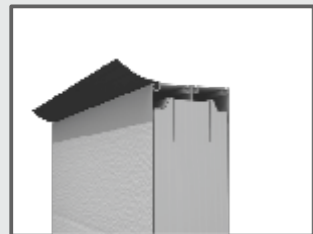

- 1 Steel
- 2 Zinc-plated layer
- 3 Primer
- 4 Finish coating
- 5 Colour

Ultra Thermo Industrial door is designed and manufactured to save Thermal energy in heated or refrigerated premises. The thermo brake between inner and outer steel surfaces and 80 mm thick, high density polyurethane insulation provides excellent thermal value of the door up to $0.5 \text{ W/m}^2 \text{ K}$.

Double rubber bottom seals protect well from energy loss.

Panel style:



Standard pattern:



Standard colour:

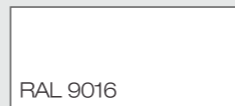

Painted RAL colours are available upon request



Pass doors are not recommended to ensure higher thermal value.

Windows Options

Round, rectangular or oval windows, with triple glazing, helps to combine requirement of visibility or light with thermal efficiency.

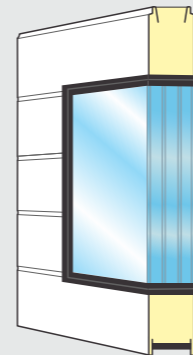
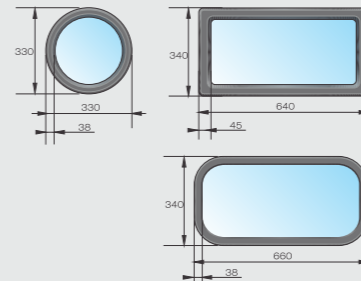

Triple pane thermal insulation

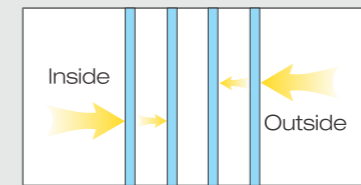

TLP - ULTRA THERMO size limitations: maximum width 12 meters, max height 8 meters, max 70 m^2 .

Lifting Types Options

STD - standard lift

STD RM

LHR FM - low headroom lift double tracks, front mounted springs

LHR RM - low headroom lift double tracks, rear mounted springs

HL - high lift

VL - vertical lift

VL - vertical lift, low mounted springs

